



Technical Documents

1: Drawings Marker Post

2: Installation

3: Product Appraisal Report

*Follow
Us On*



DRINKING WATER VARIANTS

NON-DRINKING WATER VARIANTS

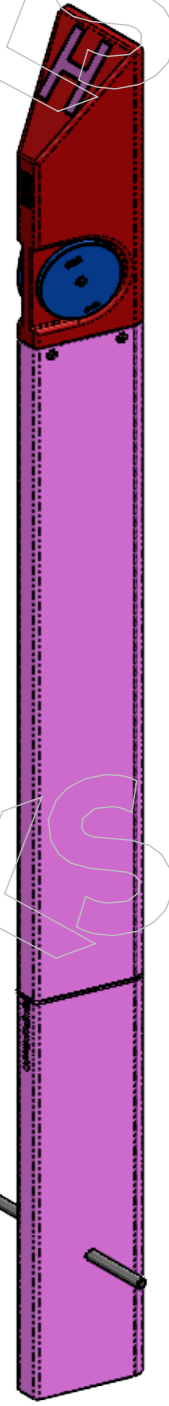
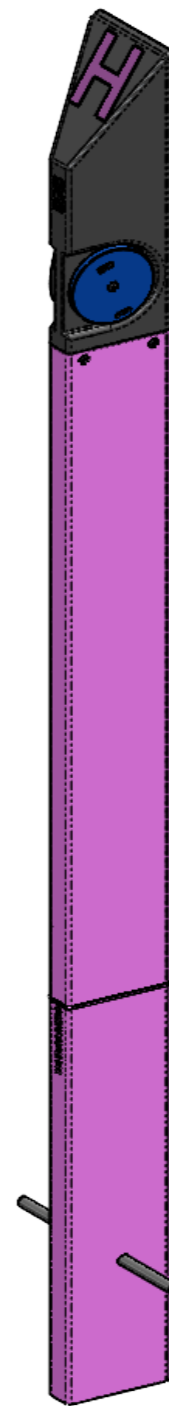
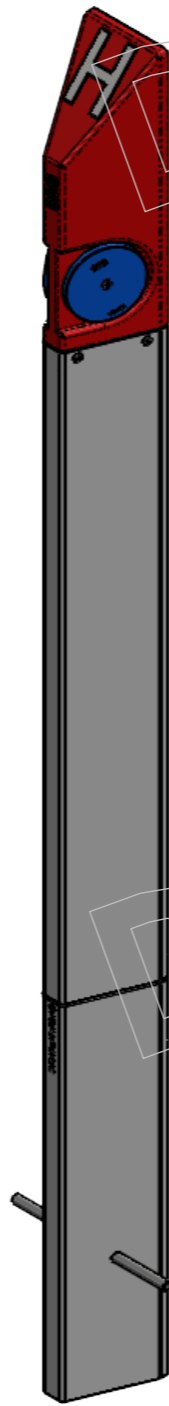
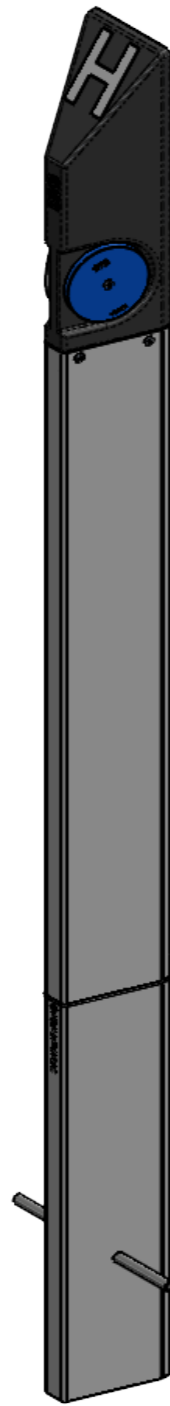
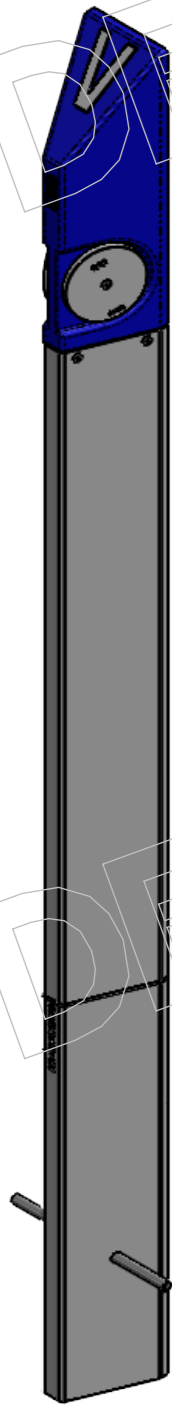

Drinking Water-Valve-Blue
MPWBV

Drinking Water-Hydrant-Black
MPWBH

Drinking Water-Fire Hydrant-Red
MPWRFH

Non-Drinking Water-Valve-Blue
MPLBV

Non-Drinking Water-Hydrant-Black
MPLBH

Non-Drinking Water-Fire Hydrant-Red
MPLRFH

Part No	Description	Material
MPWBV	Marker Post White (DW) – Blue Top – Valve 'V Embossed'	HDPE
MPWBH	Marker Post White (DW) – Black Top – Hydrant 'H Embossed'	
MPWRFH	Marker Post White (DW) – Red Top – Fire 'H Embossed'	
MPLBV	Marker Post Lilac (NDW) – Blue Top – Valve 'V Embossed'	
MPLBH	Marker Post Lilac (NDW) – Black Top – Hydrant 'H Embossed'	
MPLRFH	Marker Post Lilac (NDW) – Red Top – Fire 'H Embossed'	

Benefits

- Superior UV Resistant material, designed to withstand arid Australian conditions and maintain its reflective visibility.
- Designed to be safe – Impact safe (Car, moving object or person) and flexible “shock absorbing”.
- Designed to be light weight.
- Exclusive stackable design for transportation (pack many on top of each other).
- Special modular design for different combinations or colour codes. Switch out and use colours as required.
- Innovative structural design to maintain its strength but still flexible for safety.
- 100% Recyclable Materials. Made from HDPE – High density Poly Ethylene.

Installation

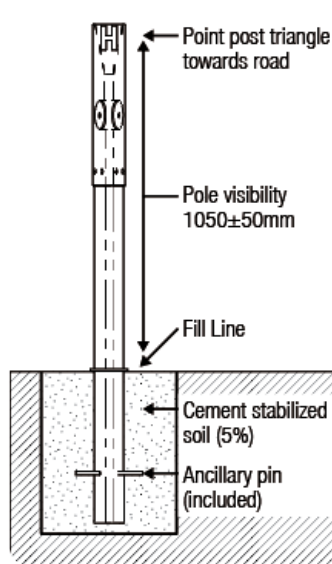

The marker post shall be anchored in the ground using an ancillary pin supplied with the product and using cement stabilised soil (5%). The visibility of the post from the fill line shall be 1050 ± 50 mm.

It should be installed 600mm or farther from the valve or hydrant (if possible), and the post triangle to be pointed to the fittings and the road. Refer to above diagram for installation details.

Please always comply with the water authorities' installation instructions if different to this recommendation.

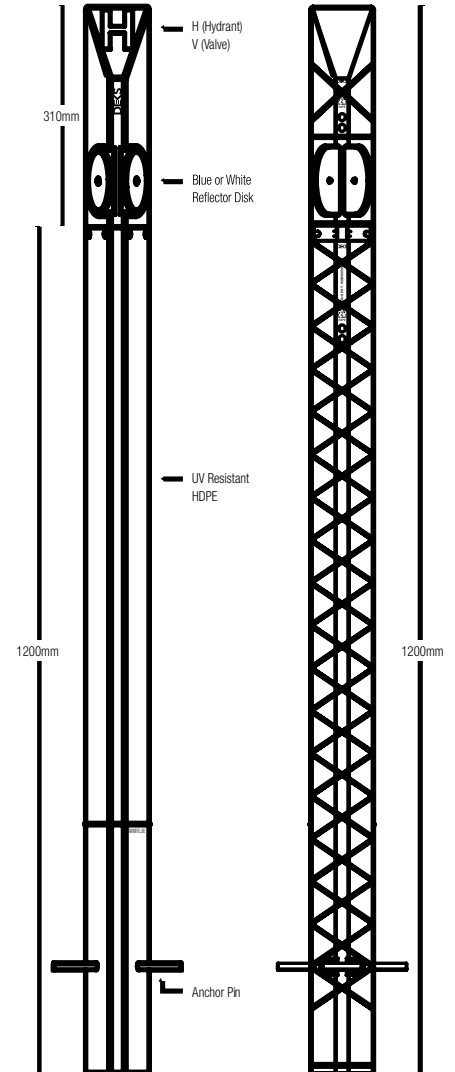

Features

- Made from HDPE – High density Poly Ethelene (UV Resistant, lightweight, Strong, Recyclable)
- Innovative structural design for strength, flexibility and impact absorption.
- State-of-the-art V shape design for structural resilience and ease of transportation.
- Featuring Interchangeable parts for a quick switch or replacement.
- Made from 100% recyclable materials.

Certificates





WSAA PRODUCT APPRAISAL CERTIFICATE

Deks Industries Pty Ltd

Polymeric Valve and Hydrant Marker Posts

This appraisal is for a range of Deks valve and hydrant marker posts moulded from polyethylene. The posts are used by various authorities including Water Agencies, Municipal Councils, Fire Authorities and Road Authorities to readily identify the type and location of installed valves and hydrants.

The posts are triangular in horizontal section with a bevel on the top surface and are 1500mm long. The range consists of white coloured marker posts to identify a hydrant or valve installed in a drinking water main and purple coloured marker posts to identify a hydrant or valve installed in a non-drinking water main.

The posts are supplied with a red coloured top to indicate a firefighting hydrant, a black coloured top to indicate an operational hydrant and a blue coloured top to indicate a valve. The letter "H" for hydrant or "V" for valve is moulded on the bevelled surface in raised form. The letters are coloured white for drinking water mains and purple for non-drinking water mains.

The marker posts incorporate 2 reflective markers riveted to the post such that they are visible from either direction of vehicle approach and are coloured blue for hydrants and white for valves.

Product Category	Marker Posts
PA Number	1914
Supplier	Deks Industries Pty Ltd
Brand	Deks
WSAA Product Specification	WSA PS 286
Issue date	11 August 2021
Expiry date	10 August 2026
Recommendations	It is recommended that WSAA members, subject to any specific requirements of the member, accept or authorise Deks PE valve and hydrant marker posts, as detailed in this report, provided any relevant conditions relating to the design, installation and acceptance testing are in accordance with relevant Agency and Authority requirements.
Disclaimer	The disclaimer on Page 2 explains a number of very important limits on your ability to rely on the information in this Product Appraisal Certificate and the assessment criteria used to underlay it. Please read it carefully and take it into account when considering the content in this Certificate.

1. Disclaimer

This Product Appraisal Certificate (Certificate) is issued by WSAA on the understanding that:

This Certificate applies to the product(s) as submitted in Schedule A. Any changes to the product(s) either minor or major shall void this Certificate.

To maintain the recommendations of this Certificate any such changes shall be detailed and notified to the Product Appraisal Manager for consideration and review of the Certificate including the product appraisal criteria underlying it and appropriate action. Appraisals and their recommendations will be the subject of continuous review dependent upon the satisfactory performance of products.

WSAA reserves the right to undertake random audits of product manufacture and installation. Where products fail to maintain appraised performance requirements the appraisal and its recommendations may be modified and reissued. Certificates will be reviewed and reissued at regular intervals not exceeding five (5) years.

WSAA reserves the right to withdraw this Certificate at any time in its sole and absolute discretion for any reason.

The following information explains a number of very important limits on your ability to rely on the information in this Certificate. Please read it carefully and take it into account when considering the contents of this Certificate.

Any enquiries regarding this Certificate should be directed to the Product Appraisal Manager Phone: 03 8605 7601 email carl.radford@wsaa.asn.au.

1.1. Issue of Certificate

This Certificate has been published and/or prepared by WSAA and nominated Project Manager and peer group of technical specialists (the Publishers).

The Certificate and the underlying product appraisal criteria have been prepared for use within Australia only by technical specialists that have expertise in the function of products such as those appraised in the Certificate (the Recipients).

By accepting this Certificate, the Recipient acknowledges and represents to the Publisher(s) and each person involved in the preparation of the Certificate and product appraisal criteria underlying it that the Recipient has understood and accepted the terms of this Disclaimer.

1.2. Limits on Reliance on Information and Recommendations

1.2.1. Disclaimer of liability

Neither the Publisher(s) nor any person involved in the preparation of the Certificate and product appraisal criteria underlying it accept(s) any liability for any loss or damage suffered by any person however caused (including negligence or the omission by any person to do anything) relating in any way to the Certificate or the product appraisal criteria underlying it. This includes (without limitation) any liability for any recommendation or information in the Certificate or any errors or omissions.

1.2.2. Intellectual Property and other rights

WSAA does not undertake any assessment of whether the importation, manufacture, sale or use of the Product the subject of this Certificate infringes the intellectual property rights or proprietary rights of any person. Recipients of the Certificate should undertake their own assessment of whether (as relevant) the importation, manufacture, sale or use of the relevant Products infringe the intellectual property rights or other proprietary rights of any person. If the Product infringes intellectual property rights or other proprietary rights there is potential for the supply of the Products to be interrupted.

From time to time WSAA and the other Publishers may receive notice of allegations that the importation, manufacture, sale or use of the Product infringes intellectual property rights or other proprietary rights. WSAA's policy is to not refer to such allegations in its Certificate or take any other steps to put Recipients on notice of such allegations. If, however, WSAA becomes aware that the allegations have been admitted or proved in Court, then WSAA may, at its discretion, take such steps as it considers appropriate. As such, Recipients acknowledge, agree and accept that WSAA may have information in its possession about intellectual property rights infringement allegations or other infringement allegations in relation to the Product which are not referred to or disclosed in this Certificate and which are not otherwise communicated to Recipients.

1.2.3. Need for independent assessment

The information and any recommendation contained (expressly or by implication) in this Certificate are provided in good faith (and subject to the limitations noted in this Certificate). However, you should treat the information as indicative only. You should not rely on that information or any such recommendation except to the extent that you reach an agreement to the contrary with the Publisher(s).

This Certificate does not contain all information that a person might require for the purposes of assessing any product discussed or appraised within it. The product appraisal criteria used in preparing this Certificate may not address all relevant aspects of the Product.

Recipients should seek independent evidence of any matter which is material to their decisions in connection with an assessment of the Product and consult their own advisers for any technical information required. Any decision to use the Product should take into account the reliability of that independent evidence obtained by the Recipient regarding the Product. Recipients should also independently verify and assess the appropriateness of any recommendation in the Certificate, especially given that any recommendation will not take into account a Recipient's particular needs or circumstances.

WSAA has not evaluated the extent of the product liability and professional indemnity insurance that the provider of the product maintains. Recipients should ensure that they evaluate the allocation of liability for product defects and any professional advice obtained in relation to the product or its specification including the requirements for product liability and professional indemnity insurance.

1.3. No Updating

Neither the Publisher(s) nor any person involved in the preparation of this Certificate or the product appraisal criteria underlying it [has] [have] any obligation to notify you of any change in the information contained in this Certificate or of any new information concerning the Publisher(s) or the Product or any other matter.

1.4. No Warranty

The Publisher(s) do[es] not, in any way, warrant that steps have been taken to verify or audit the accuracy or completeness of the information in this Certificate, or the accuracy, completeness or reasonableness of any recommendation in this Certificate.

QUALITY AND PRODUCT CERTIFICATIONS

A copy of the following Quality Certificate is available from WSAA.

TABLE A1 DEKS INDUSTRIES PTY LTD – MANAGEMENT SYSTEMS

5/841 Mountain Highway Bayswater Victoria	
Quality Systems Standard	ISO 9001:2015
Certification Licence No.	EKSQ01-CCCQ02
Certifying Agency	Equal Assurance
First Date of Certification	20 April 2017
Current Date of Certification	10 August 2020
Expiry Date of Certification	4 October 2023



PRODUCT LITERATURE

DRINKING WATER VARIANTS

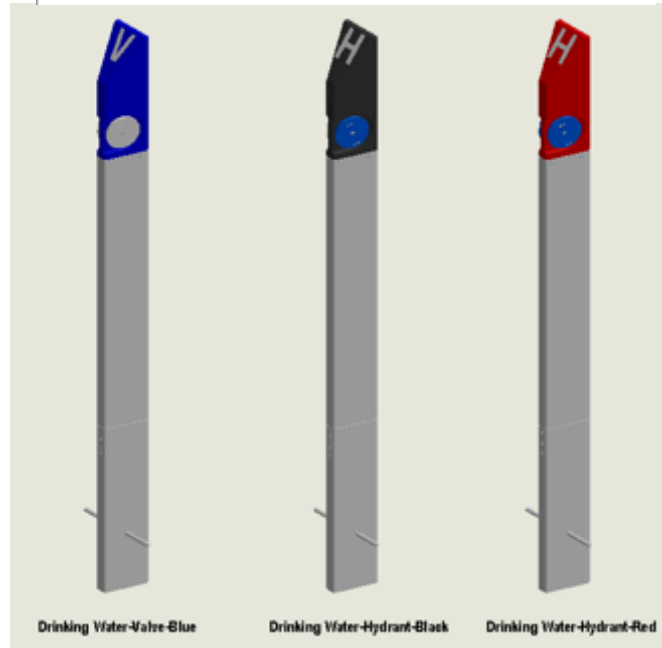

NON-DRINKING WATER VARIANTS

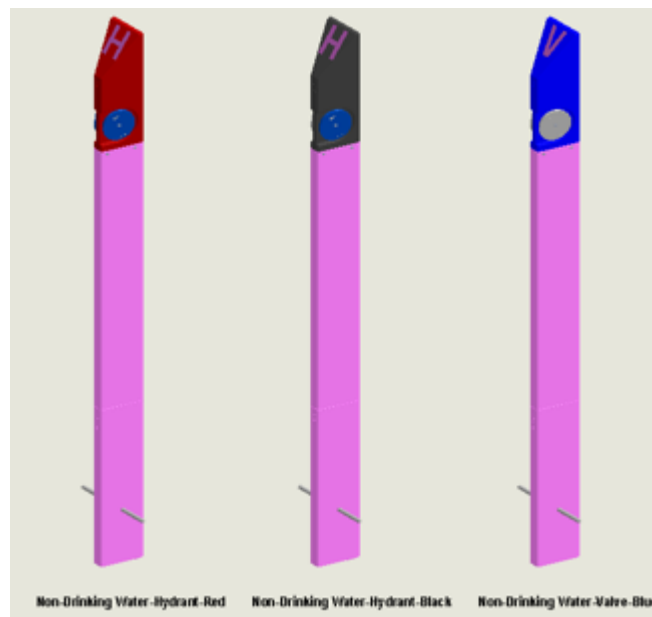



SUPPLIER CONTACTS

Deks Industries Pty Ltd

5/841 Mountain Hwy
Bayswater, Victoria 3153

Phone: +61 3 8727 8800

Email: info@deks.com.au

Website: www.deks.com.au

DEKS

*Follow
Us On*

